



**Hart & Cooley**  
*install confidence*

Hart & Cooley, Inc. 800.433.6341 *p*  
5030 Corporate Exchange Blvd. SE 616.656.8200 *p*  
Grand Rapids, MI 49512 800.223.8461 *f*  
info@hartcool.com 616.656.6399 *f*  
www.hartandcooley.com

Offered by:

**www.hartandcooley.com**  
For submittal information and other literature visit our Website.



**Hart & Cooley**<sup>®</sup>  
*install confidence*

RESIDENTIAL AND COMMERCIAL

# Flexible Duct Systems

**GREENGUARD**<sup>®</sup> Level-4 Highly Microbial Resistant rated.



Edition 4





**Hart & Cooley, Inc.** 800.433.6341 *p*  
5030 Corporate Exchange Blvd. SE 616.656.8200 *p*  
Grand Rapids, MI 49512 800.223.8461 *f*  
info@hartcool.com 616.656.6399 *f*  
www.hartandcooley.com

**Order information:**

To order Hart & Cooley products, please contact an authorized Hart & Cooley distributor or call 800.433.6341.

When you purchase Hart & Cooley products, you also receive the full support of Hart & Cooley technical and customer service.

**Technical and customer service:**

800.433.6341 toll-free  
616.656.8200 phone  
800.223.8461 toll-free fax  
616.656.6399 fax

**Internet address:**

<http://www.hartandcooley.com>

**Install confidence with these other quality**

**Hart & Cooley products available:**

- Registers, Grilles & Diffusers
- Type B Gas Vent Systems
- Special Gas Vent
- Model TLC All-Fuel Chimney
- Duct System Components
- SMART Air and Energy Solutions

FLEXIBLE DUCT SYSTEMS	Page
MODEL SELECTOR .....	1
PRODUCT INFORMATION .....	2-3
PERFORMANCE DATA .....	3
AIR DUCTS, RESIDENTIAL SERIES .....	4-5
AIR DUCTS, COMMERCIAL SERIES.....	5-6
AIR CONNECTORS AND SLEEVES.....	7
ACCESSORIES.....	8
AIR FRICTION CHART .....	9

### MODEL SELECTOR

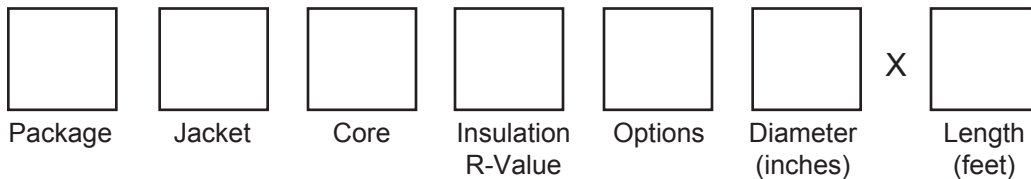

Package	Jacket	Core	Insulation	Options
F – Boxed	0 – No Jacket	0 – No Core	0 – No Insulation	CP – Compressed
FB – Bagged	1 – Black Polyethylene Jacket	1 – Double-Ply Black Polyester Core	4 – R-4.2 Insulation	UCP – Uncrimped, Compressed
	2 – Metalized Polyester Jacket	4 – Corrugated Aluminum Core	6 – R-6.0 Insulation	
	3 – Heavy-Duty (4 mil.) Black Polyethylene Jacket	9 – Multi-Ply Metalized/Polyester Core “Commercial Series”	8 – R-8.0 Insulation	

### How to Order:

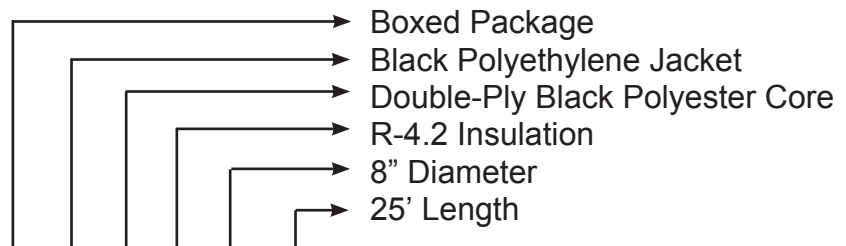

**F 1 1 4 8 25**

Disclaimer: We reserve the right to make changes in the products, product specifications, packaging and to discontinue product without notice.

# Product Information



Hart & Cooley offers flexible duct products for both residential and commercial applications, that provide the most economical solution to your air-handling needs. H&C uses Formaldehyde-Free insulation for improved indoor air quality. Available in boxes or banded bags. Custom lengths available.

**POLYETHYLENE JACKET AIR DUCTS.** These feature a durable, scuff-resistant black polyethylene vapor barrier that provides improved protection against damaging ultra-violet light. Installation is made easy with the reinforcing fiberglass yarn scrim, which acts as a rip-stop and helps prevent tearing. These air ducts feature an R-value of 4.2, 6.0 or 8.0 to fit any application, and also come in special configurations especially designed for manufactured homes.

**METALIZED JACKET AIR DUCTS.** Providing the ultimate in strength and protection, metalized polyester vapor barriers are reinforced with fiberglass scrim to provide high durability and tear resistance. The fiberglass insulation furnishes outstanding thermal protection with R-values of 4.2, 6.0 or 8.0. The metalized jacket air duct and sleeves are available with either a two-ply black polyester core (Residential Series) or high-pressure multi-ply metalized polyester laminate cores (Commercial Series) that encapsulate a high carbon steel wire helix.

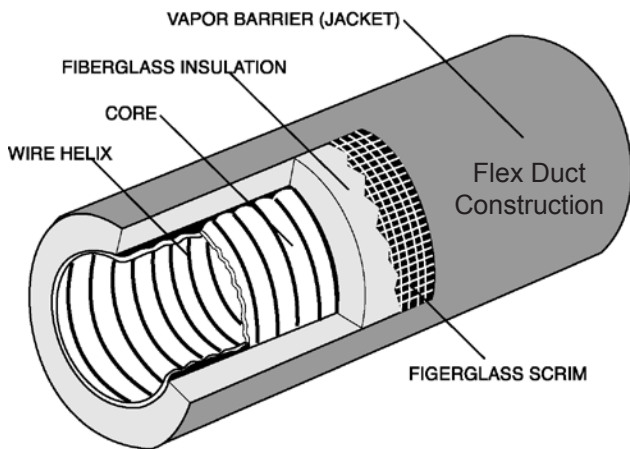

**TEN-YEAR WARRANTY.** All Hart & Cooley flexible duct products are protected by the industry's strongest warranty. Our flexible ducts are warranted to be free of defects in material and workmanship for ten (10) years from the date of shipment. (Contact Hart & Cooley, Inc. for full details.)

**ECONOMICAL AIR DUCT CONNECTORS.** Designed for high pressure applications, air duct connectors utilize either a multi-ply metalized/polyester laminate encapsulating a high carbon steel wire helix or corrugated aluminum for maximum strength and durability.

**UL-LISTED.** Hart & Cooley flexible air ducts and air connectors have been rigorously tested by Underwriters Laboratories, Inc. in accordance with UL 181, The Standard for Safety for Factory-Made Air Ducts and Air Connectors. UL is a not-for-profit laboratory with an outstanding reputation for fire safety and performance testing. Make sure that the flexible duct you buy bears this UL mark. **Our UL listing assures you that our duct cores will not promote the growth of mold.**



**ADC-CERTIFIED R-VALUES.**

All Hart & Cooley insulated flexible air ducts are certified by the Air Diffusion Council for thermal performance in accordance with the ADC Flexible Duct Performance & Installation Standards (1996). Certified R-values are essential to ensure that the product you buy meets the many regulatory energy codes. Only ADC-certified products will bear this ADC thermal certification marking.



Thermal Performance

**GREENGUARD FOR CHILDREN & SCHOOLS.**

All Hart & Cooley flexible ducts have achieved GREENGUARD for Children & Schools certification. This certification provides consumers with certified low VOC emitting products that have passed rigorous and frequent tests, which help improve indoor air quality.



**GREENGUARD LEVEL 4 MICROBIAL RESISTANT.**

All Hart & Cooley flexible ducts are GREENGUARD Level-4 Highly Microbial Resistant rated.

**THE COLLABORATIVE FOR HIGH PERFORMANCE SCHOOLS**



**AMERICAN SCHOOLS AND HOSPITAL FACILITIES PRODUCT DIRECTORY**

**CODE APPROVALS.** All Hart & Cooley flexible duct products meet or exceed the requirements of most federal, state, and local mechanical and energy codes. They comply with the International Mechanical Code (IMC), the Uniform Mechanical Code (UMC), NFPA 90A and 90B, HUD, and the California Bureau of Home Furnishings, to name just a few.



**OUTSTANDING PERFORMANCE.** All Hart & Cooley flexible duct products are performance-tested in accordance with industry standards to ensure reliability and years of service. Our core is tested (in accordance with ADC FD 72-R1) for actual installation static pressure/ temperature performance and meets the ratings specified in our catalog. Our polyester cores are also tested for microbial resistance by GEI per ASTM D6329-98. The vapor barriers are tested for permeation in accordance with ASTM test methods. Call-backs are expensive and eat away at your profits, so use flexible duct you know has been performance-tested.

**INDUSTRY INVOLVEMENT.**

Hart & Cooley is committed to the flexible duct industry and supports it through involvement in many industry-related associations, committees, and organizations. Participation in ADC and UL's industry advisory council for UL 181 allows Hart & Cooley to stay at the forefront of industry changes. You need a manufacturer of flexible duct who is involved in the industry to protect your interests.



## Performance Data

**RESIDENTIAL SERIES BLACK POLYESTER CORE**

- Rated pressure per UL 181: 12" W.C. positive, 3/4" W.C. negative (1/2" W.C. neg for 14" – 20" diameter)
- Recommended operating pressure: 6" W.C. positive for 12" diameter and under 4" W.C. positive for 14" diameter and over
- Rated maximum air velocity: 5000 FPM
- For residential and light commercial applications

**COMMERCIAL SERIES METALIZED POLYESTER CORE**

- Rated pressure per UL 181: 16" W.C. positive, 1" W.C. negative (1/2" W.C. neg for 14" – 20" diameter)
- Recommended operating pressure: 6" W.C. positive for 12" diameter and under 4" W.C. positive for 14" diameter and over
- Rated maximum air velocity: 6000 FPM
- For residential and most commercial applications

**COMMERCIAL SERIES CORRUGATED ALUMINUM CORE**

- Maximum rated pressure per UL 181: 12" W.C. positive for 10" diameter and under 8" W.C. positive for 12" diameter and over 3" W.C. maximum negative
- Rated maximum air velocity: 5000 FPM

**INSULATION R-VALUES**

- Certified by Underwriters Laboratories Inc. and the Air Diffusion Council in accordance with ADC Flexible Duct Performance and Installation Standards using ASTM C-518 at installed wall thickness on flat insulation only

**POLYETHYLENE JACKETS**

- A durable black polyethylene vapor barrier
- High tensile scrim is used under the vapor barrier to provide additional strength and tear resistance
- Perm rating of 0.1 (ASTM E96 Method "A")

**METALIZED JACKETS**

- A metalized polyester vapor barrier is constructed by sandwiching fiberglass scrim between layers of polyester to provide an outstanding combination of strength and tear resistance
- Perm rating of 0.04 (ASTM E96 Method "A")

**SURFACE BURNING CHARACTERISTICS (Class 1 Air Ducts)**

- Maximum flame spread: 25
- Maximum smoke developed: 50

**OPERATING TEMPERATURE RANGE**

- -20°F to 140°F continuous @ max. Pos. pressure
- -20°F to 180°F intermittent @ 2" W.C. Pos. pressure
- -20°F to 250°F intermittent @ 0.5" W.C. Pos. pressure
- For corrugated aluminum cores: -100°F to 250°F continuous @ max Pos. pressure

**CODE APPROVALS, CERTIFICATIONS, AND LISTINGS**

- UL 181 Listed
- IMC
- UMC
- California Bureau of Home Furnishings
- Most Federal, State, and Local codes and standards
- NFPA 90A and 90B
- HUD

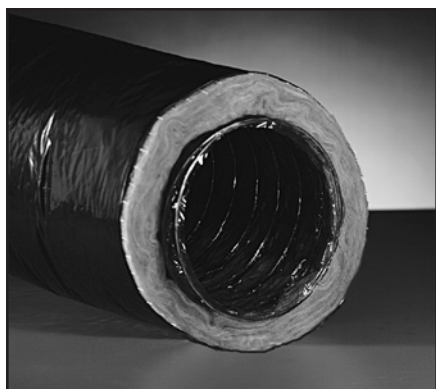

## F114 / FB114

- Black polyethylene jacket
- Double-ply black polyester core 12" W.C. positive, 3/4" W.C. negative (1/2" W.C. neg for 14" – 20" diameter)
- R-4.2
- UL-listed
- Boxed or bagged (FB series)
- 25' and 50' lengths
- GREENGUARD Level 4 highly microbial resistant

Model	Length (feet)	Diameter (inches)												
F114	25	3	4	5	6	7	8	9	10	12	14	16	18	20
FB114	25	-	4	5	6	7	8	9	10	12	14	16	18	20
F114	50	-	4	5	6	7	8	9	10	12	-	-	-	-

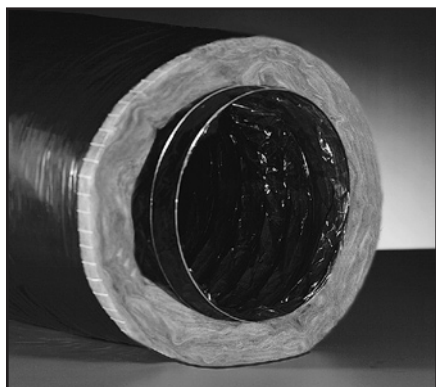

## F116 / FB116

- Black polyethylene jacket
- Double-ply black polyester core 12" W.C. positive, 3/4" W.C. negative (1/2" W.C. neg for 14" – 20" diameter)
- R-6.0
- UL-listed
- Boxed or bagged (FB series)
- 25' and 50' lengths
- GREENGUARD Level 4 highly microbial resistant

Model	Length (feet)	Diameter (inches)												
F116	25	-	4	5	6	7	8	9	10	12	14	16	18	20
FB116	25	-	4	5	6	7	8	9	10	12	14	16	18	20
F116	50	-	-	5	6	7	8	9	10	-	-	-	-	-

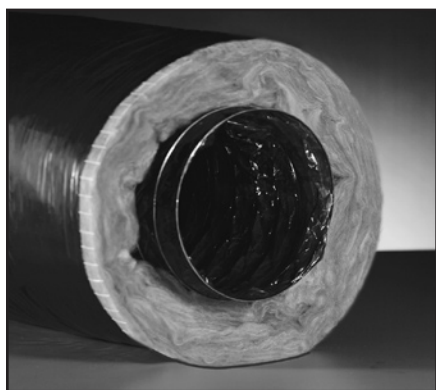

## F118 / FB118

- Black polyethylene jacket
- Double-ply black polyester core 12" W.C. positive, 3/4" W.C. negative (1/2" W.C. neg for 14" – 20" diameter)
- R-8.0
- UL-listed
- Boxed or bagged (FB series)
- 25' and 50' lengths
- GREENGUARD Level 4 highly microbial resistant

Model	Length (feet)	Diameter (inches)												
F118	25	-	4	5	6	7	8	9	10	12	14	16	18	20
FB118	25	-	4	5	6	7	8	9	10	12	14	16	18	-
F118	50	-	-	-	6	7	8	-	-	-	-	-	-	-



## F214 / FB214 / F216 / FB216 / F218 / FB218

- Metalized polyester jacket reinforced with fiberglass scrim
- Double-ply black polyester core 12" W.C. positive, 3/4" W.C. negative (1/2" W.C. neg for 14" – 20" diameter)
- R-4.2 F214,FB214 / R-6.0 F216,FB216 / R-8.0 F218,FB218
- UL-listed
- Boxed or bagged (FB series)
- 25' and 50' lengths
- GREENGUARD Level 4 highly microbial resistant

Model	Length (feet)	Diameter (inches)																		
F214	25	3	4	5	6	7	8	9	10	12	14	16	18	20						
FB214	25	-	4	5	6	7	8	9	10	12	14	16	18	20						
F214	50	-	4	5	6	7	8	9	10	12	-	-	-	-						
F216	25	-	4	5	6	7	8	9	10	12	14	16	18	20						
FB216	25	-	4	5	6	7	8	9	10	12	14	16	18	20						
F216	50	-	4	5	6	7	8	9	10	-	-	-	-	-						
F218	25	3	4	5	6	7	8	9	10	12	14	16	18	20						
FB218	25	3	4	5	6	7	8	9	10	12	14	16	18	-						

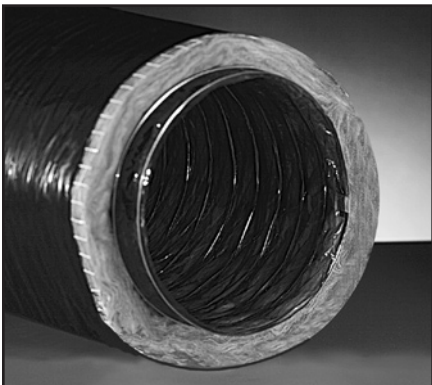

## F314 / F318

(Manufactured Home) Class 1 Air Duct

- Heavy-duty 4 mil. black polyethylene jacket
- Double-ply black polyester core 12" W.C. positive, 3/4" W.C. negative (1/2" W.C. neg for 14" – 20" diameter)
- R-4.2 F314, R-8.0 F318
- UL-listed
- 25' length
- Boxed
- GREENGUARD Level 4 highly microbial resistant

Model	Length (feet)	Diameter (inches)																		
F314	25	-	4	5	6	-	8	-	10	12	14	-	-	-						
F318	25	-	-	-	-	-	-	-	10	12	14	-	-	-						

# Commercial Series Flexible Air Ducts

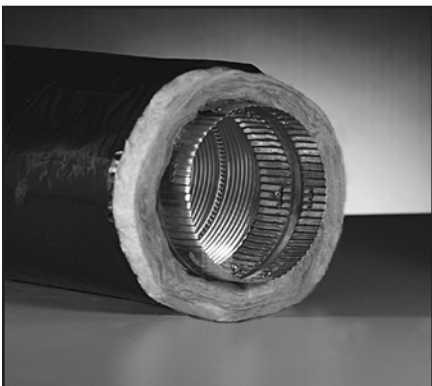

## F144 Commercial Series

- Black polyethylene jacket
- Corrugated aluminum core 12" W.C. positive, 3" W.C. negative
- R-4.2
- UL-listed
- Available in 6' and 7 1/2' lengths

Model	Length (feet)	Diameter (inches)																			
F144*	6	4†	5	6	7	8	9	10	12	14	16	18	20	22†	24†						
F144*	7 1/2	4†	5	6	7	8	9	10	12	14	16	18	20	22†	24†						

\*For California Only

†Not UL-listed



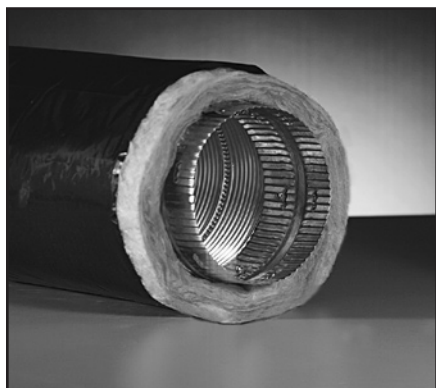

## F146 Commercial Series

- Black polyethylene jacket
- Corrugated aluminum core 12" W.C. positive, 3" W.C. negative
- R-6.0
- Available in 6' and 7 1/2' lengths
- UL-listed

Model	Length (feet)	Diameter (inches)													
F146*	6	4†	5	6	7	8	9	10	12	14	16	18	20	22†	24†
F146*	7 1/2	4†	5	6	7	8	9	10	12	14	16	18	20	22†	24†

**\*For California Only**

†Not UL-listed

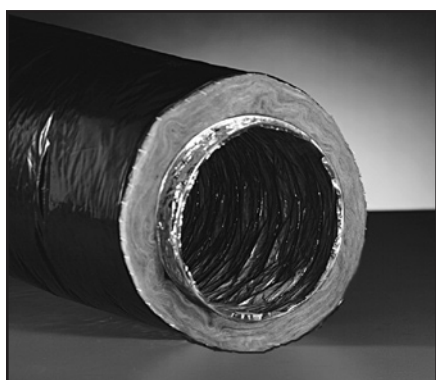

## F194 Commercial Series

- Black polyethylene jacket
- High pressure core, 16" W.C. positive, 1" W.C. negative (1/2" W.C. neg for 14" – 20" diameter)
- Multi-ply metalized/polyester core
- R-4.2
- Boxed
- 25' length
- GREENGUARD Level 4 highly microbial resistant
- UL-listed

Model	Length (feet)	Diameter (inches)												
F194	25	-	4	5	6	7	8	9	10	12	14	16	18	20

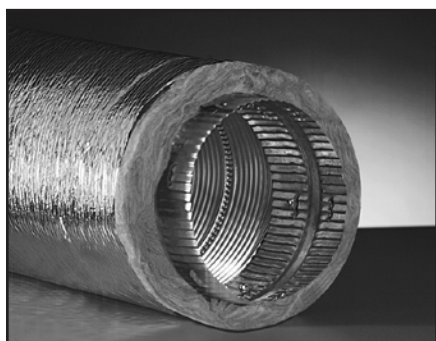

## F246 Commercial Series

- Metalized polyester jacket
- Corrugated aluminum core
- 12" W.C. positive, 3" W.C. negative
- R-6.0
- Available in 6' and 7 1/2' lengths
- UL-listed

Model	Length (feet)	Diameter (inches)													
F246*	6	4†	5	6	7	8	9	10	12	14	16	18	20	22†	24†
F246*	7 1/2	4†	5	6	7	8	9	10	12	14	16	18	20	22†	24†

**\*For California Only**

†Not UL-listed

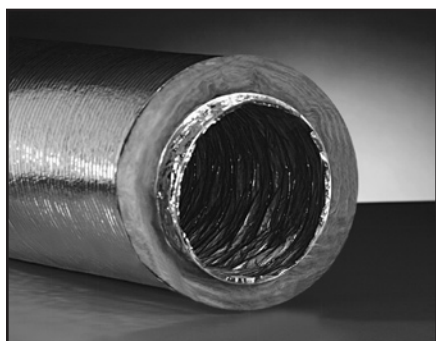

## F294 / FB294 / F296 / FB296 / F298 / FB298 Commercial Series

- Metalized polyester jacket reinforced with fiberglass scrim
- High pressure multi-ply metalized/polyester core, 16" W.C. positive, 1" W.C. negative (1/2" W.C. neg for 14" – 20" diameter)
- R-4.2 F294,FB294 / R-6.0 F296,FB296 / R-8.0 F298,FB298
- UL-listed
- Boxed and bagged
- 25' length
- GREENGUARD Level 4 highly microbial resistant

Model	Length (feet)	Diameter (inches)												
F294	25	-	4	5	6	7	8	9	10	12	14	16	18	20
FB294	25	-	4	5	6	7	8	9	10	12	14	16	18	20
F296	25	-	4	5	6	7	8	9	10	12	14	16	18	20
FB296	25	-	4	5	6	7	8	9	10	12	14	16	18	20
F298	25	-	4	5	6	7	8	9	10	12	14	16	18	20
FB298	25	-	4	5	6	7	8	9	10	12	14	16	18	20

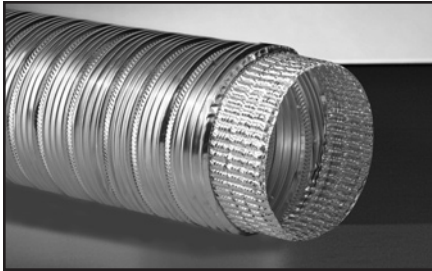

## AlumiFlex™ F040CP

- Sturdy corrugated aluminum construction
- Bulk packaged
- Class 0 air connector
- One end crimped, compressed

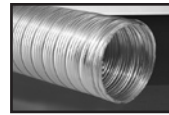

F040UCP

- Uncrimped, compressed



F040

- Male/Female collars, uncompressed
- UL-listed air duct

Series	Model	Length (feet)	Diameter (inches)															
Commercial	F040*	6	-	4†	5	6	7	8	9	10	12	14	16	18	20	22†	24†	
Commercial	F040*	7 1/2	-	4†	5	6	7	8	9	10	12	14	16	18	20	22†	24†	
Residential	F040CP	8	3†	4†	5†	6†	7†	8†	9†	10†	12†	14†	16†	18†	-	-	-	
Residential	F040UCP	8	3†	4†	5†	6†	7†	8†	9†	10†	12†	14†	16†	18†	-	-	-	
Residential	F040CP	10	3†	4†	5†	6†	-	8†	-	-	-	-	-	-	-	-	-	
Residential	F040UCP	20	3†	4†	5†	6†	7†	8†	-	-	-	-	-	-	-	-	-	

\*For California Only

Other sizes available upon request

†Not UL-listed



## F090 Commercial Series

- High pressure multi-ply metalized/polyester core, 16" W.C. positive, 1" negative. (1/2" W.C. neg for 14" – 20" diameter)
- UL and CUL listed
- 25' length
- GREENGUARD Level 4 highly microbial resistant
- Bulk packaged
- Class 1 air connector

## F010

- Double-ply black polyester core, 12" W.C. positive, 3/4" negative (1/2" W.C. neg for 14" – 20" diameter)

Model	Length (feet)	Diameter (inches)															
F090/F010	25	3	4	5	6	7	8	9	10	12	14	16	18	20			



## F104 / F106 / F108

- Black polyethylene jacket
- R-4.2 F104 / R-6.0 F106 / R-8.0 F108 (R-values valid if sleeve is used on relatively sized duct)
- UL-classified
- 5' length
- Starter cone included in each carton

Model	Length (feet)	Diameter (inches)															
F104	5	4	5	6	7	8	9	10	12	14	16						
F106	5	4	4	5	7	8	9	10	12	14	16						
F108	5	4	5	6	7	8	9	10	12	14	16						

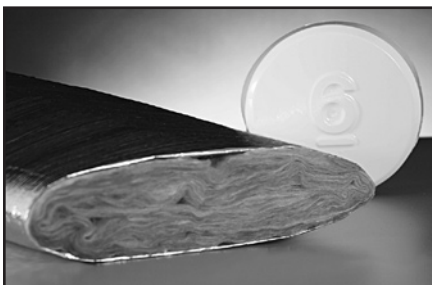

## F204 / F206 / F208

- Metalized polyester jacket
- UL-classified
- R-4.2 F204 / R-6.0 F206 / R-8.0 F208 (R-values valid if sleeve is used on relatively sized duct)
- 5' length
- Starter cone included in each carton

Model	Length (feet)	Diameter (inches)															
F204	5	4	5	6	7	8	9	10	12	14	16						
F206	5	4	4	5	7	8	9	10	12	14	16						
F208	5	4	5	6	7	8	9	10	12	14	16						



Black



Silver

### Duct Tape

- Acrylic adhesive won't dry out
- Single-ply polypropylene backing
- Tears easily by hand
- UL-listed and marked UL-181B-FX

Part No.	Description	Size
011371	Black	2" x 120 yards
011372	Silver	2" x 120 yards



**IMPROVES AIRFLOW!**

### SMART Flow Elbow

- One size fits 4" to 16" flex duct.
- Eliminates flex duct kinks and restrictions
- Can be used for new and retrofit applications
- UL-2043 Classified

Part No.	Description	Pieces per Case
630500	SMART Flow Elbow	25
636501	SMART Flow Elbow Kit Kit includes 2 Flow Elbows and 4 36" duct straps	24 (2/polybag)

# Air Friction Chart for Flexible Duct only

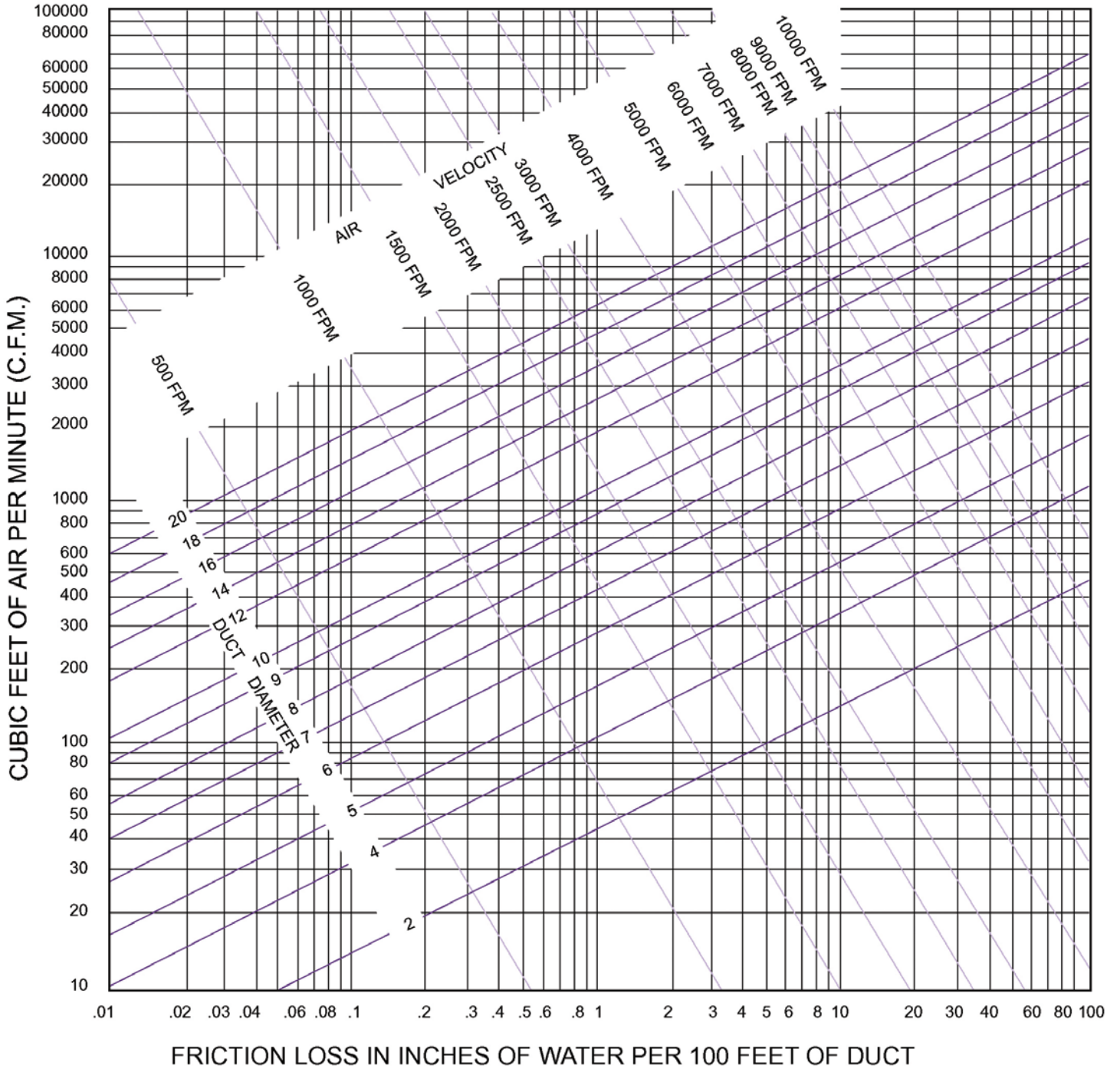

To order product literature, please contact  
Customer Service toll-free at 800.433.6341.